

First light from SPIRAL

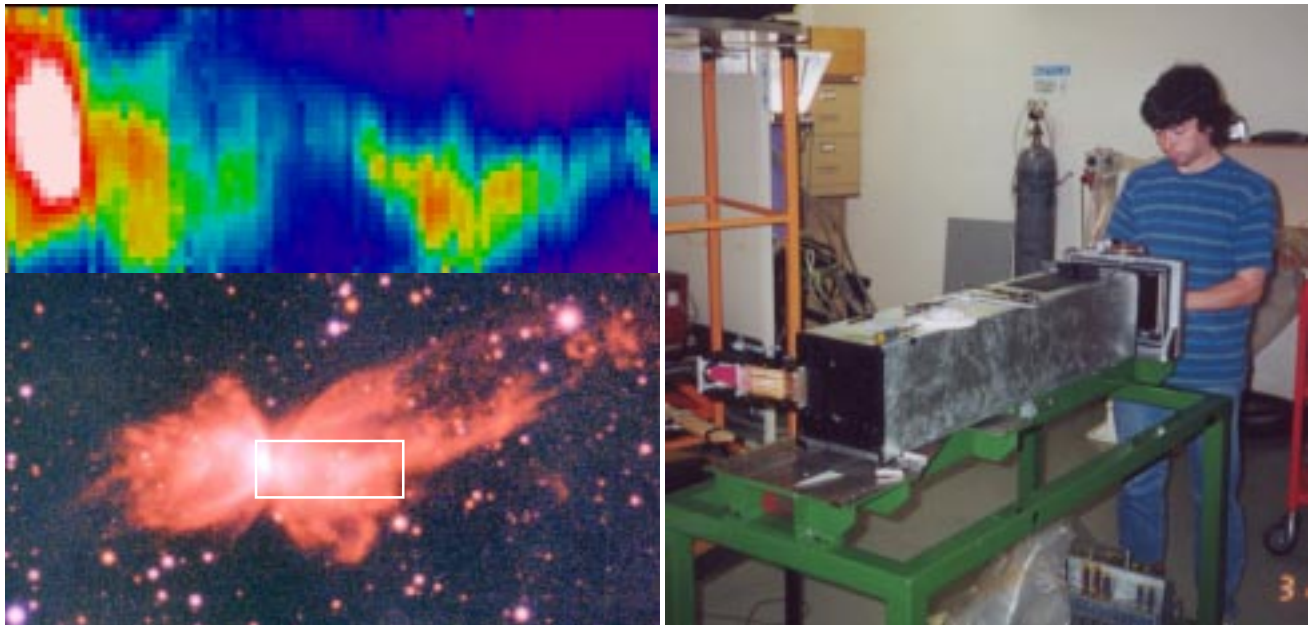

SPIRAL, the new integral field unit for the AAT, has been successfully commissioned. The right panel shows instrument scientist David Lee carrying out the last stages of assembly of SPIRAL at the telescope. See page 8 for a full report. A large number of targets were observed in the excellent conditions, including Planetary Nebula NGC 6302 shown in the lower left panel from an AAT plate. This PN is known for its unusually high ejection velocities, suggesting a particularly energetic explosion. SPIRAL was used to scan the inner region of the nebula (shown by the white box), and the resulting map of [NII] emission is shown in the upper left panel. These observations were taken at eight positions, with 10 – 60 second exposures.

DIRECTOR'S MESSAGE

It is perhaps paradoxical that, at a time when the AAO is arguably enjoying its highest productivity both scientifically and technically, it faces its most significant challenge for the future. Recent planning processes in both Australia and UK reveal that the two communities have increasingly different priorities for the future of the AAO.

The report produced by the astronomy panel in the PPARC's long-range review process does not include continued operational support for the AAT as a high priority. Rather it emphasises the need to re-use existing facilities such as the AAO in a way which will bring added value to higher priority items in the UK's program (e.g. Gemini, VISTA, MAXAT).

In contrast, the report on the Future of the AAO endorsed by the National Committee for Astronomy in Australia saw a continuing need for Australian astronomers to use the AAT both as a general-purpose/wide-field 4m-class telescope and as a support telescope for Gemini for at least the next decade. However, both communities recognise, and wish to continue, the advantages that flow from the collaboration between Australia and the UK made possible by the AAT Agreement.

The UK's current planning process also coincides with the forthcoming anniversary date of the AATB agreement: 22 February 2001. The next meeting of the AAT Board at Oxford in August will be the last Board meeting before that date. At their March meeting the Board asked me, as AAO Director, to propose a future operational model for the AAO which sought to fulfil the scientific priorities of both communities whilst maintaining the agreement.

Over the past 25 years the AAO has gained an enviable international reputation for excellence, particularly in scientific and technical fields associated with wide-field/survey astronomy. In any revised model for the AAO, the goal must be to focus on these areas to maintain the AAO's competitiveness.

Based on input received from AAO staff, I propose to submit a first draft of this future operational model to the AAO Users' Committee at the beginning of June. The AAO Users' Committee will be given the responsibility of soliciting feedback from the community prior to its meeting on 22/23 June. Based on input received at this meeting the model will be revised and a final version submitted to the AATB at the beginning of August. The key elements of the draft model are:

- A significant reduction in the operating costs of the AAT
- Using resources made available by the reduction in operating costs to fund instrument development at the AAO in new programs seen as a high priority by both Australia and UK (e.g. Gemini, MAXAT).
- A focus on internationally-competitive survey science which the AAT is uniquely equipped to carry out (e.g. coordinated VISTA wide-field spectroscopic follow-up, planet search)
- A flexible approach to the split between survey and general-purpose usage of the AAT.
- In the long term, planning a future for the AAO that is independent from the AAT

This model is far-reaching in its scope and implications. Nevertheless, I believe strongly that these are the sorts of bold steps the UK/Australian partnership will have to take if the AAO is to fulfil the future scientific needs of the communities. I look forward to developing this plan with the AAO community over the next few months.

Brian Boyle

TTF OBSERVATIONS OF OPTICAL LINE EMISSION AT LARGE RADII IN COOLING FLOWS

Walter Jaffe (Leiden) & Malcolm Bremer (Bristol)

Bright optical line emission is detected in most cooling flow clusters, but only in the immediate vicinity of the central galaxy (usually an AGN) and not from the cooling flow itself, which extends out more than 100 kpc. The large scale gas cooling from 10^7 K to 10 K should emit $H\alpha$ photons along the way, and the surface brightness should be a few times 10^{-18} erg/s/cm²/arcsec². This is a factor of ten below what is possible to detect with narrow band filters (c.f. Heckman et al. 1989, ApJ 338, 48) but a nice challenge for the Taurus Tunable Filter (TTF). This system, used with “charge shuffling” between the on– and off–bands is extremely good for removal of sky and continuum emission; these are usually the limiting factors in finding low surface brightness emission.

In August 1998 we observed 5 cooling flow clusters and 1 non-cooling flow radio galaxy and were somewhat surprised by the results. Figure 1 shows a line emission map around the popular southern cluster Abell 2597. The image is the result of 1 hour observing at the AAT and has been convolved to 1" resolution (0.37"/pixel). At this point of the reduction we have not yet found the diffuse emission, but have found bright filaments extending out some 50 – 60 kpcs from the center. We

found similar filaments in Sersic 159–03.

At this point it is not yet clear what these filaments are. There is no close correlation with the structure of the radio emission. The most plausible theories are that either the cooling flow itself is very lumpy (at least by the time it reaches 10,000 K) or that we are seeing a late type galaxy in the process of being digested by the central cluster galaxy. We hope that the follow-up spectra of these filaments that we have from the VLT will decide the matter.

The computed detection limit of the map shown is about 5×10^{-18} erg/s/cm²/arcsec², or just above what we thought necessary to detect the diffuse emission. Combining all the images we have, and smoothing the data to bring up the low surface brightness features, should reduce the detection limit by almost a factor of 20.

A systematic problem which we will have to solve before reaching the limit is the removal of the “bowl”. This is a background feature caused by slow variations of the central wavelength of our chosen TTF bandpass (10 Å) with distance from the field center. The phase effect is 16 Å from centre to edge, independent of wavelength, over the 10 arcmin field. The centre of the field is free of OH emission and therefore goes very deep. But the phase effect picks up an OH line towards the edge of the field. Bright sky lines in either the on– or off–bands induce a radially variable, non-subtracting background in the observations. We are presently investigating a number of different methods for background removal.

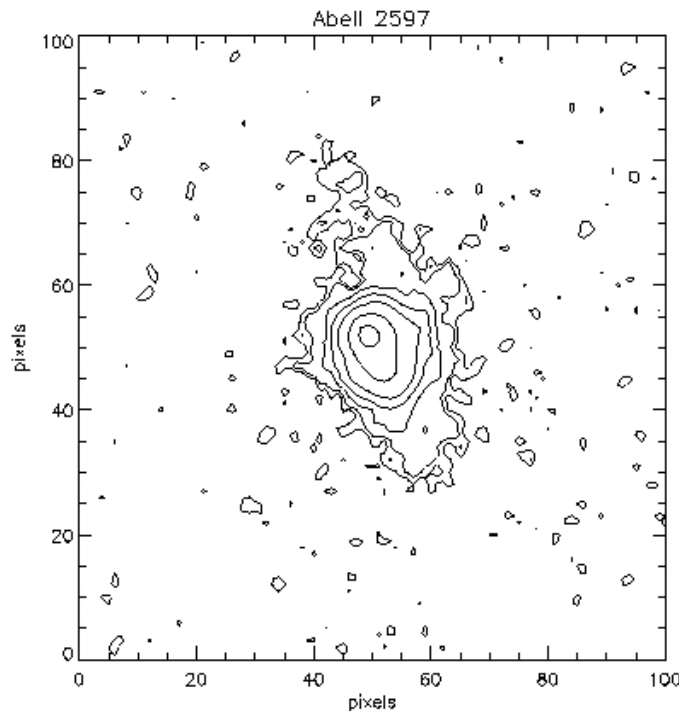

Figure 1: $H\alpha$ line emission extending over 20 arcsec in the cluster Abell 2597. The field of view shown is 37 arcsec by 37 arcsec at 1 arcsec resolution.

DISCOVERY OF TWO NEW WOLF-RAYET STARS FROM THE AAO/UKST H-ALPHA SURVEY

Q. A. Parker (Wide-Field Astronomy Unit, Edinburgh), D. H. Morgan (Institute for Astronomy, Edinburgh) & D. Russeil (Helsinki Observatory, Finland)

Two new Wolf-Rayet stars have been discovered during spectroscopic follow-up of Planetary Nebula (PN) candidates on the SAAO 1.9-m Telescope. The candidates were found from preliminary visual searches of wide-field exposures from the AAO/UKST H-alpha survey. The new Wolf-Rayet stars and their nebulae exhibit quite different characteristics both visually and spectroscopically, one being late, of type near [WC9], and the other a hotter object of type [WC4] or earlier which exhibits several unusual features and is the subject of further study.

Both objects were noted as potentially interesting PN candidates, in that they had obvious central stars within their external circular nebulae. Most of the 700+ PN candidates discovered so far by our PN search programme have shown little evidence of central stars due to their extremely faint, extended, often highly evolved nature (Parker et al, in preparation).

H-alpha Survey images of the two nebulae are given in Figure 1. Figure 1a (left) shows a nearly circular nebula with an enhanced SE limb around a faint ($R_{equiv} \sim 18$) central star. The diameter of the nebula is around 83 arcseconds. The object has a position of 09:28:41 -49:36:47 (J2000) with $l, b = 272.84 +1.03$ and was found on H-alpha Survey exposure HA18350 (field

274). According to SIMBAD and the latest Strasbourg-ESO Catalogue of Galactic PN (Acker et al. 1996), there is no known PN or WR star at this location within a search radius of 1 arcminute though a possible IRAS source is noted (IRAS 09269-4923). This is the earlier object.

Figure 1b (right) shows a faint circular nebula with a diameter of about 31 arcseconds around a brighter central star ($R_{equiv} \sim 13-14$). This has a position 11:34:38 -52:43:33 (J2000) with $l, b = 291.32 +8.41$ and was found on H-alpha Survey exposure HA17969 (field 278). No known PN or WR star was found in SIMBAD or Acker et al. but again an IRAS source was noted (IRAS 11322-5226). This is the late WC object.

Preliminary spectra for the two central stars are given in Figure 2. Only the region around 5800 Å is reproduced here. In the upper spectrum of the hotter star, the gaussian FWHM of the C IV doublet at 5805 Å is 48 Å with an EW of ~2000 Å. This is comparable to both Pop I WC4 stars (Smith et al. 1990) and the stronger-lined CSPN such as NGC 6751 (Tylenda et al. 1993). Similarly, in the lower spectrum, measurements of the strong C III line at 5696 Å are EW 90 Å, FWHM 11 Å which are a little smaller than those for both WC9 and [WC9] stars, though larger than for [WC10] stars (Crowther et al. 1998).

Preliminary estimates of the photometry of these stars suggests that they are CSPN rather than Pop I WR stars. According to the compilation by Tylenda et al. (1993), there are 39 CSPN of Wolf-Rayet type (excluding those with very weak emission lines) with 5 being [WC9] and 13 [WC4] or earlier, so our new stars make useful contributions to the total sample.

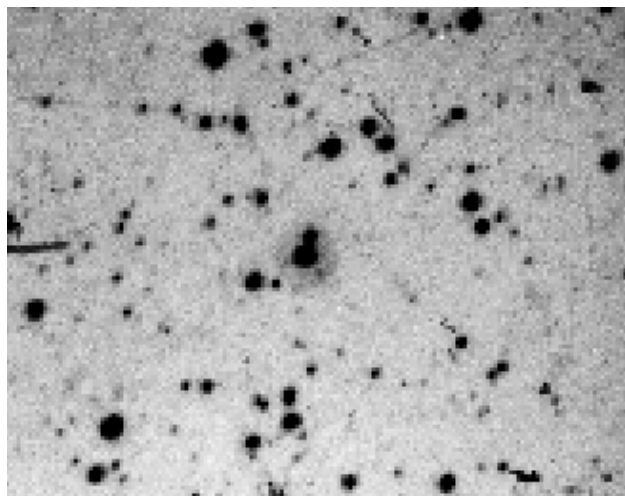
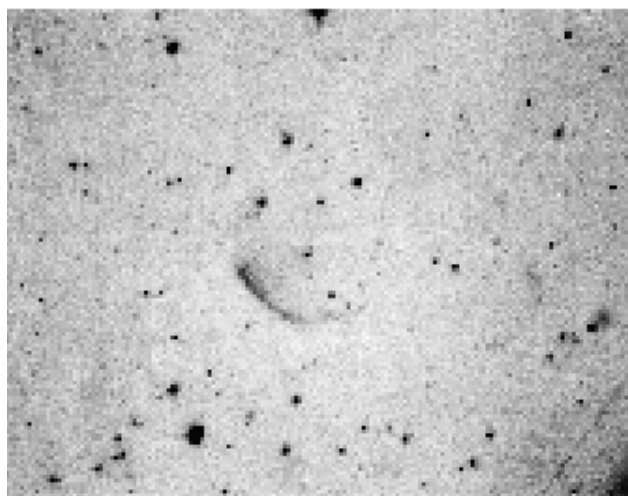

Figure 1: New WR stars with outer nebulae taken from the original H-alpha survey discovery exposures. Fig.1a (left): Hotter, probably [WC4], star; Fig.1b (right): Cooler, probably [WC9], star. Each image is 6 x 4.6 arcminutes across.

2DF MOVIE RELEASE

Brian Boyle (AAO), Chris Fluke & Matthew Bailes (Swinburne U.)

The 2dF Galaxy Redshift Survey team celebrated observing galaxy number 100,000 this month. The 2dF survey is now four times larger than the CfA Survey; previously the largest galaxy survey. It is perhaps appropriate that this month 2dF has also embarked upon a movie career, with the release of "2dF, The Movie".

A collaboration between the 2dFGRS team, AAO and the Centre for Astrophysics and Supercomputing at Swinburne University has resulted in the largest-ever computer visualisation of a trip through the Universe based on actual data collected by astronomers. The movie takes us through the fibres of 2dF out of the AAT dome to travel through the slice of the sky covered by the 2dFGRS. Galaxies are shown at the actual catalogue position, reproducing observed voids and clusters. Each galaxy is represented by scanned photographs of nearby galaxies from AAT and UKST plates.

The Swinburne Centre for Astrophysics and Computing is one of Australia's newest and most rapidly expanding astrophysics research facilities. The centre operates a supercomputer cluster consisting of 64 Compaq workstations, and a Virtual Reality theatre powered by an XP1000 workstation.

It is the first time that actual data have been used to create a simulation like this. The result is a scientifically-based but visually stunning educational tool that will eventually be available to the public. To celebrate the movie release this newsletter includes a poster-quality centrefold of one of the 'stills' from the movie. It shows our virtual spaceship travelling through a galaxy cluster, with the slice of 2dF galaxies spread out before us. The honeycomb structure of the universe is clearly evident.

The movie can be viewed at

<http://www.swin.edu.au/astronomy/2dfmovie>

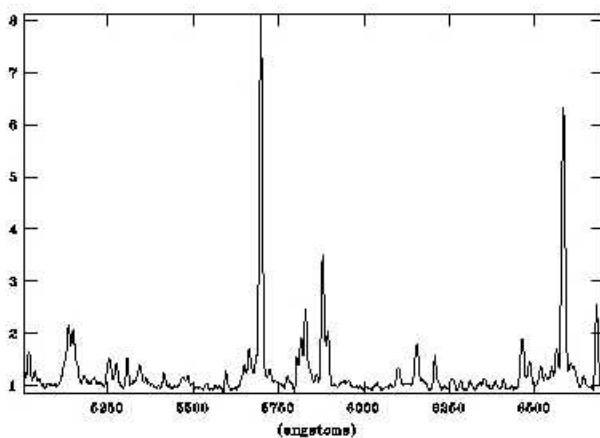
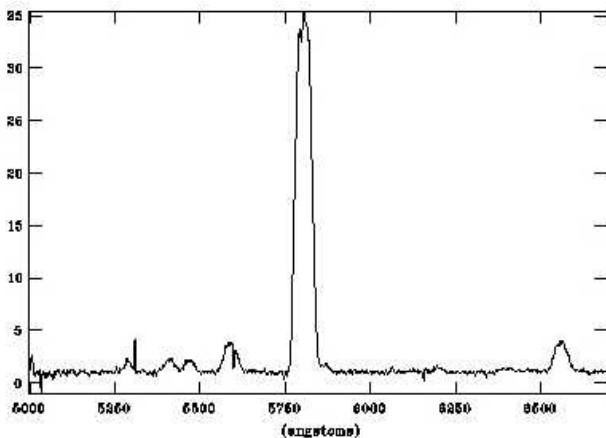

Figure 2: SAAO 1.9-m low resolution spectroscopy of the two WR stars. The 1700 Å region around 5800 Å is displayed. Fig.2a (top): early type; Fig.2b (bottom): late type.

Additional observations and analysis of these two new WR stars will be given in Parker and Morgan (MNRAS, in preparation). Further details of the non-proprietary H-alpha Survey and associated research projects can be found at:

<http://www.roe.ac.uk/wfau/halpha/halpha.html>

References

- Acker, A., Marcout, J., Ochsenbier, F., 1996. First Supplement to the ESO-Strasbourg Catalogue of Galactic Planetary Nebulae, Observatoire de Strasbourg
- Crowther, P.A., de Marco, O., Barlow, M.J., 1998. MNRAS, 296, 367
- Smith, L.F., Shara, M., Moffat, A.F.J., 1990. Astrophys. J., 348, 471
- Tylenda, R., Acker, A., Stenholm, B., 1993, Astr. Astrophys. Suppl Ser., 102, 595

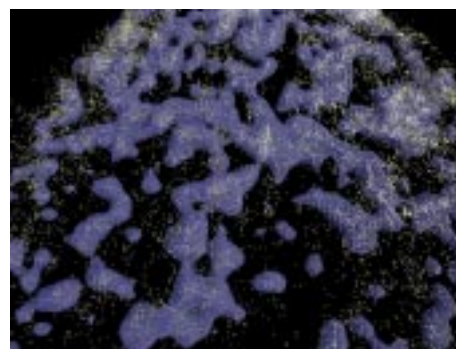

Another still from the movie, showing the smoothed large-scale structure observed in the 2dFGR catalogue.

THE STAR-FORMATION HISTORY OF LUMINOUS FIELD EARLY-TYPE GALAXIES AT REDSHIFTS $z \sim 0.4$

Jon Willis (U. Catolica de Chile), Paul Hewett (IoA), Steve Warren (IC) & Geraint Lewis (AAO)

Over the past decade, studies of luminous early-type galaxies in rich clusters out to redshifts $z \sim 0.5$ have revealed much about their evolutionary history. The evolution of the Fundamental Plane (FP) versus redshift is in accordance with the predictions of passively evolving stellar populations. Combined with an intrinsically low dispersion, this implies that the majority of early-type galaxies in clusters were formed at some early ($z > 2$) coeval epoch (e.g. Pahre et al. 1998; Jørgensen et al. 1999). This conclusion is strongly supported by the impressively uniform colours of luminous early-type galaxies in rich clusters out to redshifts $z \sim 1$ (Stanford et al. 1998). An exceptionally narrow range of colours is observed both internally and between clusters at significant cosmological look-back times (5–6 Gyr, $q_0 = 0.5$).

That old stellar populations dominate the stellar content of massive early-type galaxies within clusters agrees well with the predictions of semi-analytic models of

galaxy formation (Kauffmann 1996). Luminous early-type galaxies in clusters are predicted to be the result of an early phase of vigorous merging in high-density environments, whereas field early-type galaxies are the product of a more recent and protracted merging epoch. Within these models, field early-type galaxies are predicted to display lower mean ages and a greater dispersion in star formation histories than early-type galaxies in clusters. However, the observations to date of luminous early-type galaxies at significant redshift have been confined to rich galaxy clusters and it has not been possible to examine the properties of early-type galaxies as function of environment due to the lack of a suitable sample at significant redshift.

Our strategy has employed APM measures of UKST B_JRI plates to identify a population of relatively bright ($m_R < 20$, red $B_J - R > 2.2$) galaxies with a surface density of only $\sim 50 \text{ deg}^{-2}$. In September 1998 we obtained spectra of ~ 500 objects over two nights using the 2dF facility on the AAT. The observations confirm that our sample does indeed consist of luminous (i.e. $M_V - 5 \log h < -20$) field early-type galaxies at redshifts $0.3 < z < 0.6$ with an impressive degree of completeness (97%). 485 such early-type galaxies were identified from the 2dF spectra. Even the current generation of bright, wide-angle redshift surveys (e.g. the 250,000 object 2dF Galaxy Redshift Survey) will only generate a few tens of

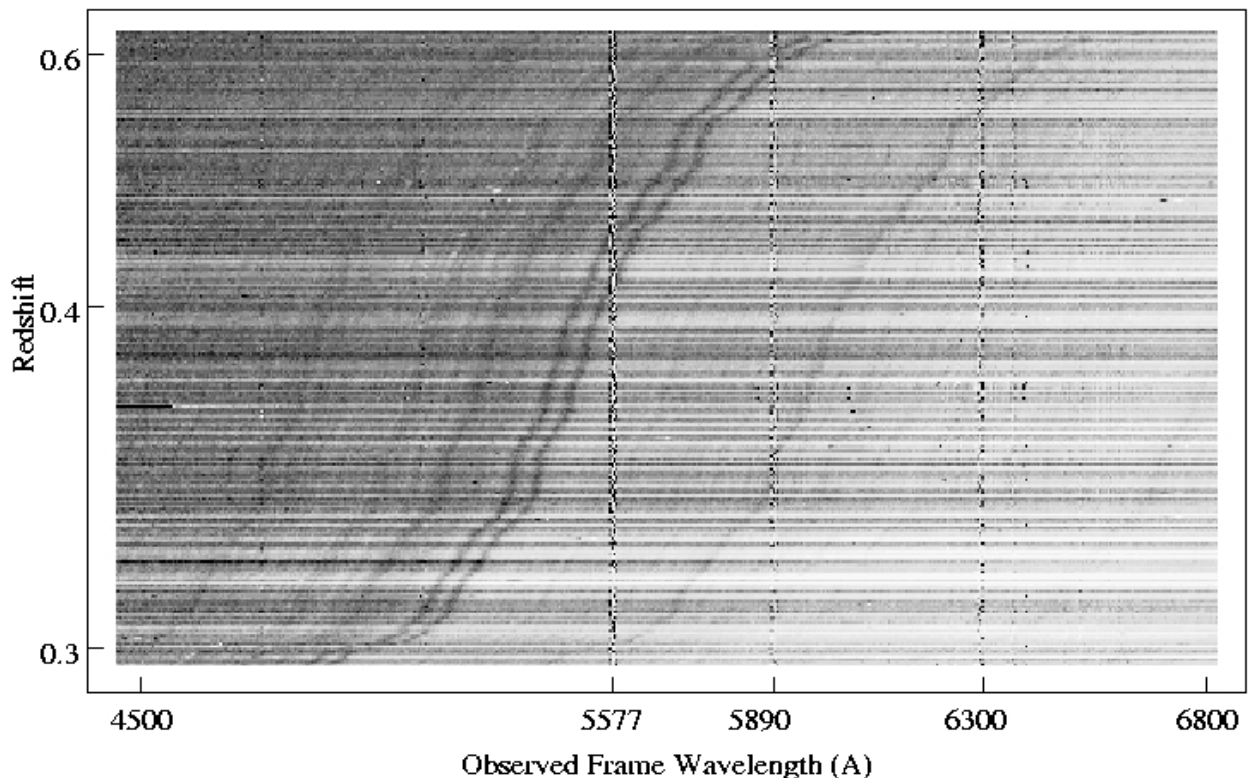

Figure 1: Observed-frame spectra of 485 distant early-type galaxies, redshifts $0.3 < z < 0.6$, arranged by increasing redshift. A number of prominent night-sky features are visible as vertical lines while features present in the galaxies, such as Calcium H+K and the G-band, move to longer wavelength with increasing redshift.

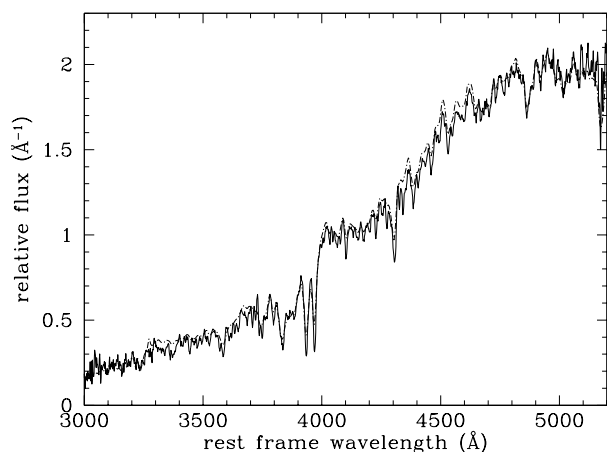

Figure 2: The composite early-type galaxy spectrum generated from the 2dF sample (solid line) compared to a local early-type galaxy template (dashed line). The match between features on scales $< 1000 \text{ \AA}$ is striking and provides further evidence for identification of the 2dF sample as early-type galaxies.

luminous early-type galaxies at redshifts $0.3 < z < 0.6$.

Our unique sample provides the ideal galaxy population to investigate the dependence of star-formation history as a function of galaxy environment. The absolute magnitudes and redshifts match those of galaxies studied in clusters studies — Figure 1. The luminosity function of the sample (Willis 2000) confirms the space density of galaxies in the sample is equivalent to that of early-type galaxies at redshift $z = 0$ thereby ensuring the galaxies are truly representative of the early-type population as a whole. This observation is reinforced by the striking visual match between the composite early-type galaxy spectrum and a representative local early-type galaxy template (Kinney et al. 1996) — Figure 2.

The B_JRI colours of the early-type galaxies constrain the age and metallicity of the underlying stellar population. Observed galaxy colours are compared to a range of model predictions based upon the GISEL96 spectral synthesis code for an early-type galaxy represented by a 1 Gyr burst of star formation and a Scalo Initial Mass Function (e.g. Pozzetti et al. 1996). Figure 3 compares the predicted colours of model galaxies observed at $z = 0.39$ to the median $B_J - R$ colour of 137 galaxies occupying the redshift interval $0.37 < z < 0.41$. This subset, chosen to minimise potential confusion due to any differential colour evolution, represents a ‘snapshot’ of $\sim 25\%$ of the galaxy sample present in a narrow redshift interval. The early-type galaxies are consistent with a well-defined locus of age and metallicity, a result that is strikingly similar to that found for luminous early-type galaxies in rich clusters at comparable redshifts (Ferreras et al. 1999). In each case, the permitted locus of age and metallicity is consistent with two scenarios; either early-type galaxies were formed over a range of epochs (e.g. $2 < z_f < 5$) with

metallicity strongly dependent upon formation epoch, or they formed at an approximately coeval epoch with a characteristic metallicity.

The common star-formation history of luminous early-type galaxies in the field and rich clusters appears to contradict the predictions of semi-analytic models of galaxy formation. However, although the stellar populations of luminous field early-type galaxies appear to be old ($z_f > 2$), the extent to which they form a coeval population must be confirmed by performing follow-up observations. We intend to obtain spectroscopy in order to determine central velocity dispersions and metallicities for ~ 40 luminous early-type galaxies drawn from the 2dF sample. Combined with surface photometry, to determine the galaxy radii, the observations will allow the construction of the FP-relation for luminous field early-type galaxies. A direct comparison to the FP for galaxies in rich clusters will provide a powerful test of star-formation history as a function of environment.

References

- Ferreras, I., Charlot, S., Silk, J., 1999. *ApJ*, 521, 81
 Jørgensen, I., Franx, M., Hjorth, J., van Dokkum, P., 1999. *MNRAS*, 308, 833
 Kauffmann, G., 1996. *MNRAS*, 281, 487
 Kinney, A., Calzetti, D., Bohlin, R. C., McQuade, K., Storchi-Bergmann, T., Schmitt, H.R., 1996. *ApJ*, 467, 38
 Pahre, M., Djorgovski, S. G., de Carvalho, R. R., 1999. *AJ*, 116, 1591
 Pozzetti, L., Bruzual, G., Zamorani, G., 1996. *MNRAS*, 281, 953
 Stanford, S. A., Eisenhardt, P. R., Dickinson, M., 1998. *ApJ*, 492, 461
 Willis, J. P., 2000. PhD Thesis, University of Cambridge

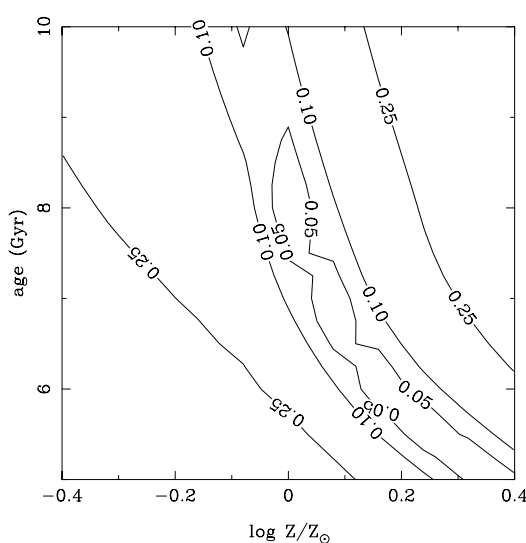

Figure 3: Absolute $B_J - R$ colour difference between GISEL96 model early-type galaxies of specified age and metallicity and the median colour of early-type galaxies occupying the redshift interval $0.37 < z < 0.41$. The well-defined locus indicates the permitted range of age and metallicity of the underlying stellar population.

SPIRAL COMMISSIONING REPORT

David Lee

At the end of March the AAO successfully commissioned SPIRAL, the new integral field spectrograph for the AAT. Integral field spectroscopy (IFS) is a technique which provides a spectrum for each spatial element in an extended two-dimensional field. The SPIRAL concept was first trialed on the AAT in 1997 using an integral field unit (IFU) built at the Institute of Astronomy in Cambridge (see Parry 1997). Following the success of the prototype the AAO decided to build a more ambitious IFU, with a larger number of fibres and increased field of view (see Lee 1999 and Lee 2000), which has now been commissioned.

Instrument Overview

The SPIRAL instrument consists of four main components: fore-optics, microlens array, fibre feed and spectrograph. SPIRAL is located at the $f/8$ cassegrain focus of the AAT with the fore-optics and IFU input fixed on an optical bench (see Figure 1). The fore-optics produce a magnified image of the telescope focal plane. At the IFU input an array of 512 square microlenses, arranged in a pattern of 32×16 lenses, samples the magnified image with each lens feeding light into an optical fibre. The lens array provides a contiguous field of view of $22'' \times 11''$ with $0.7''$ per microlens. The optical fibres transfer the light 18 m from the cassegrain focus to the spectrograph. SPIRAL has a purpose built bench-mounted spectrograph, situated below the telescope on the dome floor, which provides a stable observing environment. At the IFU output the fibres are reformatted into a slit. A row of 32 fibres on the sky is mapped to a slitlet in the output slit — there are 16 such slitlets. Thus adjacent fibres on the sky become adjacent fibres in the spectrograph, except at the ends of rows.

Commissioning

SPIRAL was commissioned between March 28 and March 30 by David Lee, Keith Taylor, Jeremy Bailey and Russell Cannon, with night assistants Gordon Schafer and Frank Freeman. Initial preparation of the instrument involved mounting and aligning the optics at the telescope focus, installation of the fibre feed, and adjustment of the spectrograph settings. Care has to be taken to ensure the safety of the fibre feed as it hangs up to 6 m vertically from the bottom of the cassegrain cage to the dome floor. Quite often during large telescope slews the commissioning team had to check the fibre feed to ensure that it did not become tangled, so we were kept busy running up and down between the control room and the dome floor.

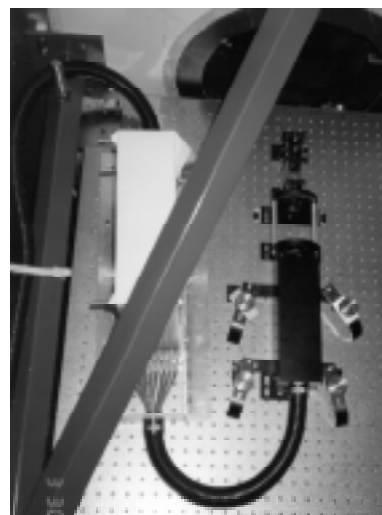

Figure 1: Photograph of the SPIRAL optical bench inside the cassegrain cage of the AAT. The rectangular black box is the IFU input. The fore-optics are above the IFU input. A strain relief box can be seen to the left. The black protective tubing contains the optical fibres.

There were few difficulties with the preparation of SPIRAL and by evening twilight of the first commissioning night we were ready to start doing some astronomy. However, the first flatfield exposure raised a few eyebrows as only the bottom portion of the detector was illuminated with spectra. A quick trip down to the spectrograph soon revealed that the shutter had fallen off blocking most of the light! This was quickly fixed by the application of double sided tape in the appropriate place. For the next three nights clear skies and sub-arcsecond seeing meant that a variety of astronomical objects could be observed, with a range of spectroscopic parameters. A large number of observations were made to test and demonstrate the performance of SPIRAL.

Performance of SPIRAL

The performance of the new fibre feed was excellent. The imaging quality and spectral resolution are as predicted, the components are well-aligned, and almost all fibres are correctly positioned with uniform throughput. We are also very pleased that none of the 512 fibres are broken. The performance of the spectrograph was also generally very good, fully consistent with ray-tracing expectations. The entire system throughput (including the telescope and atmosphere) is high, around 12–14% at 650 nm. The spectrograph provides good focus across the full field (longwards of about 480 nm), with a compact and symmetrical PSF (~ 2.7 pixels FWHM), and the level of scattered light is low. There is significant cross-talk between adjacent fibres, but this is not a serious problem because adjacent fibres correspond to adjacent pixels on the sky (except for the slit-block ends) and the $0.7''$ fibres optimally sample the image in typical seeing. The design philosophy was to maximise the number of channels which could be fitted on the detector.

Good data were obtained for a range of astronomical targets, including planetary nebulae, YSOs, galaxies, AGNs and standard stars. The data reduction software, a modified version of 2dfdr written by Jeremy Bailey, performed well and allowed the quick reconstruction of spatial images for selected wavelength regions. An example of the data is shown on the front cover. Most of the data were taken using the 316R grating, which provides wavelength coverage of 1350Å at 3.5Å resolution, or the 1200V grating to cover 350Å at 0.9Å resolution. SPIRAL can be used with any of the AAO diffraction gratings.

Current status

SPIRAL will be available as an expert user instrument from semester 01A. This means that observers should discuss the proposal with the instrument scientist to assess feasibility before submission, or have an expert as a collaborator who will take part in the observing. Astronomers wishing to apply for time on SPIRAL are encouraged to contact David Lee (dl@aoepp.aao.gov.au) or Russell Cannon (rdc@aoepp.aao.gov.au) for further details.

Note that at present, SPIRAL cannot be used bluewards of 480 nm because the spectra are merged and cannot easily be extracted. This is due to the curved focal surface of the spectrograph at these wavelengths. Working in the B/UV region should become possible for narrow bands, however this mode was not commissioned because of the current difficulties with data reduction and focusing.

More details from the commissioning tests, together with examples of the type of data obtainable, will be put on the AAO SPIRAL Web pages as they become available, see <http://www.aao.gov.au/astro/spiralb.html>.

The commissioning team would like to thank all AAT staff involved in the commissioning of SPIRAL. Thanks are also due to Antonio Cesar de Oliveira, Ligia de Oliveira, and Roger Haynes for their help with the construction of SPIRAL.

References

- I. R. Parry et al., 1997, Proc SPIE 2871, p1235.
- D. Lee, 1997, AAO Newsletter, No. 89, p9.
- D. Lee & K. Taylor, 2000, Proc SPIE 4008, in press.

NEW CASSEGRAIN ACQUISITION CAMERA

Steve Lee

The long-overdue replacement of the Quantex intensified TV camera used at Cassegrain (cass) has finally taken place. After some months of testing, a commercial CCD camera, Apogee AP-8, is now the default system for cass, as the first stage in upgrading the cass A&G unit. The Quantex continues to be available at cass as an off-slit guiding facility, which is not yet available with the Apogee, and as a backup system. We expect to buy a replacement for the Quantex for 2dF guiding shortly.

The CCD system is based on an engineering grade SITe 1K chip which is thermoelectrically cooled to around -30° C. It provides a field of 2.7 arcmin sq. with 0.16" pixels. It is typically binned by 3 for acquisition, with a readout time of < 6 sec. The spare set of 50-mm square KPNO BVRI interference filters have been installed in the filter wheel. The camera is operated from a PC mounted in the cassegrain cage. The PC runs the Linux operating system and is connected by ethernet to the local network. The night assistant simply logs on

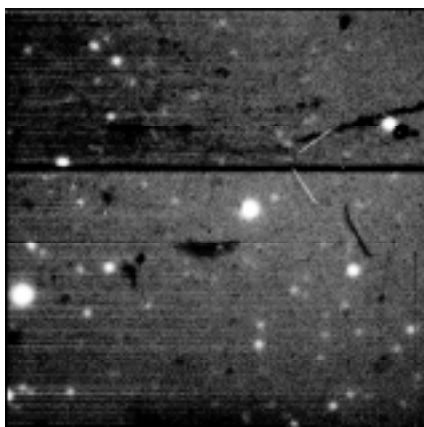

to the computer from the X-terminal in the control room and runs the appropriate software.

Compared to the Quantex, the CCD offers significantly higher QE, especially in the red, and improved dynamic range, resulting in better operations in bright moonlight and overall improvement in limiting magnitude. The accompanying image shows a single 10 sec integration through an R filter of the field of Circinus X-1, reflected off the RGO spectrograph slit jaws. In the 1.2 arcsec seeing and almost full moon the R=19.5 X-ray binary was visible (but down the slit in this image and so not seen!). The arrow points to a star of similar magnitude next to the slit. (Note that the marks seen in the image are from the deteriorated reflection surface of the 24 year old slit jaws.) This level of performance, particularly in the strong moonlight, could never have been achieved with the Quantex.

We hope to eventually use the Apogee as a scientific imager for target-of-opportunity applications, but at present we are limited by the level of dark current at the current detector temperature. This could be improved by the addition of a liquid coolant heat exchanger. In the future we will write our own, telescope-aware, software to control the camera, thus allowing point-to-acquire operation as well as autoguiding.

EXTERNAL PROJECTS AT THE AAO

Peter Gillingham, Keith Taylor, Stan Miziarski, Urs Klauser & Roger Haynes

Introduction

The AAO has built up, some might say, an enviable reputation in instrumentation, with IRIS and 2dF prime examples of successful projects incorporating ground-breaking technology. These efforts continue as IRIS II, SPIRAL and 6dF near completion (see articles in this and earlier newsletters).

During the past few years, the expertise built up through these instrumentation projects has provided the foundation for new directions for the AAO as a source of instrument design for telescopes at other sites such as the VLT, Subaru and Gemini.

These External Projects are self-funded. The large number and complexity of these projects could not be handled without modern project planning methods. Each project has a Project Manager and Project Scientist,

with overall guidance from the head of instrumentation, Keith Taylor, and chief project manager Chris Evans. The work load has been handled by a substantial increase in short term appointments, including instrument scientists, engineers, technicians and programmers. This increase will have been noted by devoted readers of the Epping Events column. Offices have been built or upgraded to handle the influx. New labs have also appeared, including the fibre assembly facility tucked into the far reaches of the CSIRO workshop.

Summary of Projects

The External Projects undertaken up to May 2000 are:

- **AUSTRALIS:** a design study for a spectrograph and fibre positioner for the ESO VLT. This project subsequently evolved into OzPoz which is due for completion in late 2001.
- **OSIRIS:** an optical imager/spectrograph for the 10.1-m GTC (Gran Telescopio Canarias). Ivan Baldry and Joss Hawthorn have undertaken a design study to incorporate tunable filters, high efficiency VPH

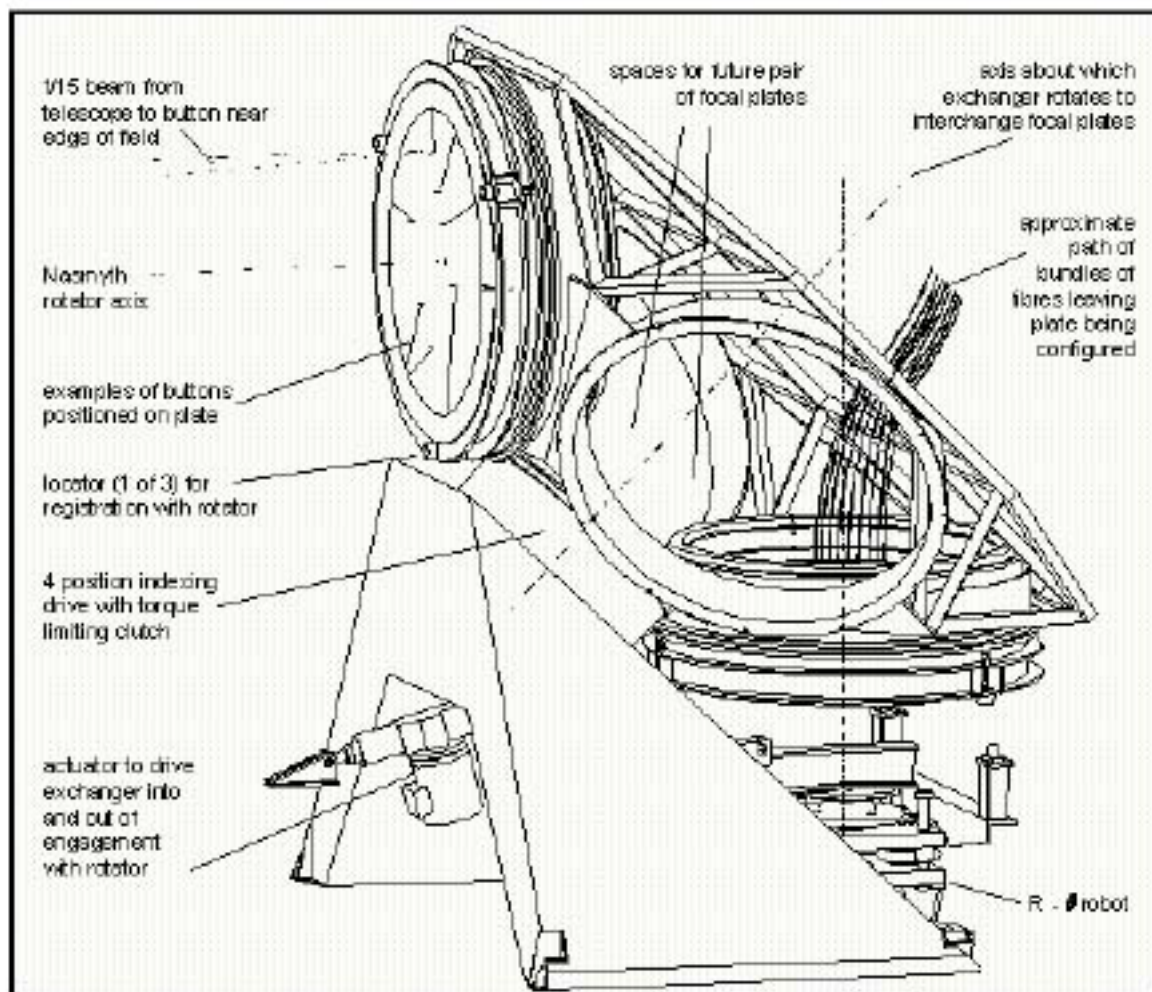

Figure 1: View of OzPoz showing the front of the focal plate in observing position.

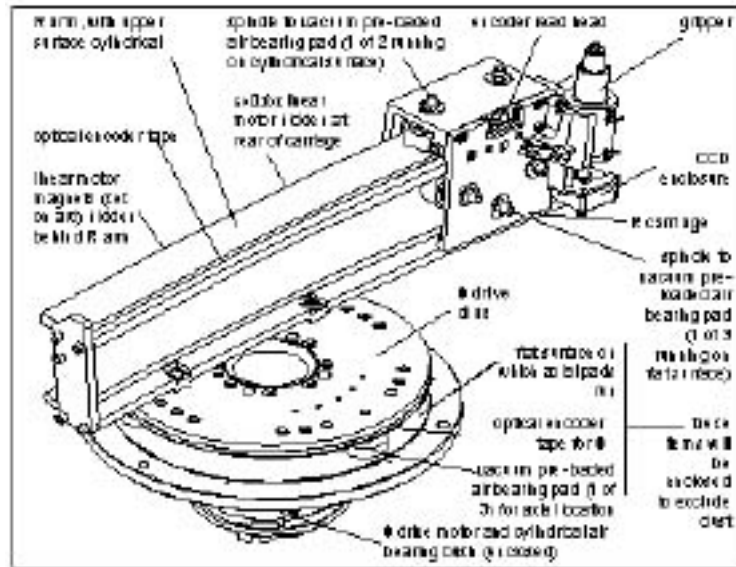

Figure 2: Details of the R- θ robot.

(volume phase holographic) gratings, charge shuffling on the CCD detectors and articulated cameras. The project was completed in January.

- **IRIS2g**: a clone of IRIS II for Gemini. The concept design study was completed in April.
- **OzPoz**: a multi-fibre positioner for the 8-m VLT in Chile. The final design has recently been accepted by ESO and the manufacturing phase is underway, with expected completion in late 2001.
- **SOAR**: An IFU unit similar to SPIRAL is being built for SOAR telescope by Cesar de Oliveira (on secondment from Sao Paulo Observatory) in collaboration with David Lee.
- **ECHIDNA**: a multi-fibre positioner designed for the Prime Focus of the Subaru telescope. Successful prototypes have been made and a preliminary design is close to completion.
- **GIRMOS**: design of robot-driven integral field units (IFUs) for a multi-object infrared spectrograph on Gemini.
- **ANDES**: a proposed future generation infrared spectrograph for the VLT. It makes use of the new VPH technology. A design study has just begun.

Details of GIRMOS are given on the Back Page, and a description of two other projects, OzPoz and Echidna, follows.

OzPoz

OzPoz (Figure 1) will feed the GIRAFFE spectrographs on the Nasmyth platform on VLT's UT2 telescope. Like 2dF, its fibres are fed from prisms in buttons which attach magnetically to steel focal plates. A robotic system will

position the buttons, and the two plates will be interchanged so that one is configured while the other is gathering light, as with 2dF.

However, OzPoz has a number of novel features, most notably the use of a pneumatically operated gripper which uses air bearings to ensure friction free rotation and high accuracy. The robot motions also have air bearings, with vacuum pre-loading. The focal surface behind the Nasmyth corrector is spherically curved so the focal plates are similarly curved. Consequently the robot (Figure 2) operates in R- θ coordinates, with the R motion along an arc matching the focal plane. As in 2dF, the fibres are lightly tensioned in retractors.

The exchanger is locked to the VLT instrument rotator during observations. To interchange plates, the whole exchanger is driven on linear bearing rails several cm away from the rotator. The tumbler then rotates by 180° and the exchanger advances again to engage the newly configured plate with the rotator. The positioner robot then rises into engagement with the plate to be reconfigured.

The gripper is operated pneumatically with solenoid valve control and its rotation is entirely free of static friction. While it is being carried to a new position, the button must rotate with respect to the R carriage. Rather than drive this rotation, it naturally follows the tension on the fibre. The gripper is very accurate – the prototype demonstrated repeated positioning of a button to within 1 μm . The prototype R drive moves 150 mm and settles to within 1 μm (the encoder resolution) in less than 0.3 sec. The RMS error in placement of buttons without iteration is predicted from an error budget analysis to be < 4 μm , substantially better than required for the VLT Nasmyth.

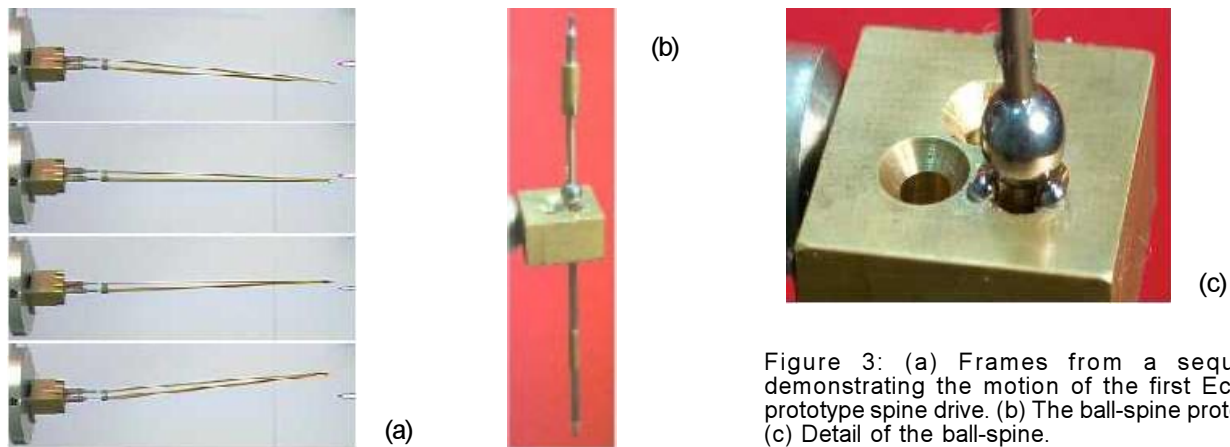

Figure 3: (a) Frames from a sequence demonstrating the motion of the first Echidna prototype spine drive. (b) The ball-spine prototype. (c) Detail of the ball-spine.

Echidna

At the $f/2.30$ arcmin diameter prime focus of the Subaru telescope, it is planned to position about 400 optical fibres for feeding near-infrared spectrographs. The area of the field is about 10 times less than for 2dF, while the number of fibres is the same, so the 2dF technique of placing magnetic buttons is not practical. Instead, Echidna employs a new concept where each fibre is held on a spine which is tilted so that its tip can be positioned anywhere within a circle. For 400 fibres, the pitch of fibres on a uniform triangular pattern is ~ 7 mm. With 7 mm radius as the range for each spine, the success rate in allocating fibres to 400 targets randomly scattered over the field is $\sim 90\%$. With the $f/2$ beam, a misalignment of the fibre axis with the telescope optical axis, due to the spine's tilt, of about 0.05 radian is just acceptable. For 7 mm tilt we need spines 140 mm long.

One mechanism for tilting the spine is to mount the base at three points, of which two can be moved axially. Since each point would need a separate actuator, this limits the size of the actuator to 3.5 mm outside diameter. Luckily, such devices are available. The smaller model of the Nanomotor is 3.3 mm in diameter and is capable of driving as far as 5 mm (much further than required). The Nanomotor has resolution in stepping mode of < 10 nm and will maintain position with power off. The only

technical limitation of the Nanomotor is that its load limit while driving is only ~ 3 gram. This requires the 140 mm spine to be of very light construction. A prototype spine has been made with Nanomotors as drivers. The spine, in the form of a tripod, using silica struts 0.67 mm outside and 0.54 mm inside diameter, deflects less than 20 micron at its tip while pointing horizontally, and it requires less than 2 gram Nanomotor force to raise it (Figure 3a), so the motors are capable of doing the job.

An alternative technique for driving an Echidna spine was suggested by David Henderson of Burleigh Instruments Inc. and a prototype has been constructed (Figure 3b,c). In this case a quadrant piezo tube is mounted on a ball, which sits on three smaller balls cemented in a block of brass. When an alternating voltage with sawtooth waveform is applied across opposite electrodes, the piezo bends relatively slowly in one direction and quickly on the return. The return acceleration causes the larger ball to slip on the small balls, resulting in a slight tilt. The results from the prototype are encouraging - with a 400V p-p sawtooth, the angular steps of the spine are ~ 17 micron for a 140 mm long spine. It operates satisfactorily at all required orientations and can be incremented by as little as 1 micron. Further study is needed to fully assess the relative merits of the two drive systems.

EPPING EVENTS

This quarter the AAO welcomes Scott Croom who arrived in February to take up a position as Research Assistant to the Director. He comes from Imperial College of Science, Technology and Medicine where he was Post Doctoral Research Assistant. His interests are QSO environments and properties. Kevin Davies has become our newest recruit as software engineer working on OzPoz. It's also good to have Greta Simms back, three days a week, from maternity leave. Carolyn Hampele will stay on through the End of Financial Year blues, but we will lose her in July when she plans to visit China. Another person we'll miss is Shane Tan who has finished his contract draughting position.

We've had a number of lunches to celebrate the annual board's visit and the passing of various project milestones. Keep up the good work guys so we can justify more free chicken! And congratulations to David Malin for receiving the Griffith Observatory Star Award for his AAO Images web page.

LETTER FROM COONABARABRAN

Rhonda Martin

For the driest continent on Earth (barring Antarctica) Australia has been quite damp of late. Bit of an understatement really when one thinks about it. First of all there was Cyclone Steve who softened us all up while inundating the west and exterminating a few towns. Next off the rank was Cyclone Tess who, I think, drowned Queensland — it must be disconcerting to have to share the only dry roof in a vast area of water with a marine crocodile who's tired of swimming. I know that in times of natural crisis all animals rub along together by ignoring the existence of their natural predators and prey — a truce, in fact — but I don't know that 5-m Salties have read the treaty and I would rather not have to rub any bit of me along one in case that particular bit disappeared.

The next cyclone should have started with a U but no-one could think of a name beginning with that letter — had they not heard of Uther or Ulbrig? So then there was Victor and yet another one, whose name escapes me, all dumping a lot of moisture — quite a lot of it on the AAT! Never in my life do I remember so many cyclones in a season and I heard on the news last night that yet another was forming.

All of this water has to go somewhere, and judging by the bad language of a lot of wild-eyed, corridor-prowling astronomers, most of it is around Siding Spring Mountain, but, of course, that isn't true — it just seems that way! These persons have also taken to looking at Gavin Dalton from the corners of their eyes which bodes ill for this unassuming Englishman. He is usually on 2dF and you all know what THAT means. This time he was using LDSS but he did admit to going to have a look ('just a little one!') at 2dF — need I say more? If these cyclones keep coming we might even get to Cyclone Gavin before winter.

I have it on good authority that John Stevenson's sheep have dug out and refurbished their snorkels and flippers again but think on the bright side — inland Australia will be absolutely glorious this Spring. Lake Eyre is filling for only the fourth time this century and the deserts will be ablaze with beauty. If you are thinking of visiting this wonder, think again — mainly about sinking out of sight in the mud, and NO-ONE WILL KNOW!

You will read elsewhere about the successful commissioning of SPIRAL and we add our congratulations to the team. Congratulations are also due to Ian Lewis and Alison Offer on the birth of their baby girl, Hannah Mollie. Hannah entered the world at a respectable 3.44 kg and has been expanding ever since, as babies are wont to do. She also has her own passport

and I guess the picture will have to be updated quite regularly.

The Board also had its annual visit to the mountain and was once again fed a great lunch. Their visit coincided with aluminising and I could be wrong here (a rare occurrence, I know) but I think it is the first time that a Board (apart from commissioning days) has actually seen the mirror removed and aluminised. It is always a wonderful dance to watch and Frank and his boys did themselves proud.

Our two Robs cause some confusion to outsiders. Not only do they share a first name but they are both very tall and thin. Rob Patterson, in electronics, is younger and has a passion for country music. Rob Dean is, um, more mature, and drives around with his head out of his sun-roof — he says he likes the wind in his hair (along with the numerous flying insects like bees, grasshoppers, crickets, moths and the odd kangaroo it would seem). Rob, Dean that is, is also the only person I know who can sit with crossed legs and still have both feet on the floor. I am very envious of this feat — no pun intended.

LIBRARY NEWS

Sandra Ricketts

Since the last Library News column in the November issue, numerous new books have been received in the AAO library. Many are still on the display shelves, but if you need to know what has arrived recently, ask the librarian (lib@aaoepp.aao.gov.au) to put you on the list to receive quarterly updates on new books.

Lists of preprints received are emailed to interested staff each week, and a monthly list can be found on the library web page at <http://www.aao.gov.au/AAO/library/preprintsreceived.html>.

Several more journals are now available on-line through the library's web page: <http://www.aao.gov.au/AAO/local/www/lib/jnls.html> including the long-awaited RAS Monthly Notices. Don't forget to visit the library page - it does change and evolve!

Several people have inquired about searching the library catalogue on-line — this facility has been available for some time at <http://www.aao.gov.au/library/libsearch.html>. Searching can be done by author, title or keyword.

The AAT library has been bursting at the seams again, and to help solve this problem new shelving has been installed in the corridor outside the library. These shelves will house all the issues of Astrophysical Journal held at the telescope library - some have already been moved there from one of the studies and the rest will follow soon. Some further rearrangement of journals in the library and the studies will then be carried out.

TAKING AAO TO THE OUTBACK

Fred Watson

Over the years, many AAO astronomers have found themselves involved with National Science Week, Australia's annual science-promotion jamboree. It's usually good fun, but is seldom a life-changing experience. For two of us, though, this year's National Science Week has been entirely different. David Malin and I have just spent an unforgettable seven days participating in an event with the appealing title of "Science in the Pub goes Outback". It has been an amazing week, in which the everyday faded from sight and the extraordinary became commonplace.



The recipe was simple. Take 20 scientists, science journalists, media movers and shakers; add one photographer and one composer. And a guitar. Shake them well in a veteran DC3 aircraft, and ferry them around some of the remotest areas of Queensland and New South Wales. At each venue, hold a series of lively, upbeat events: "Science in the Pub" (two scientists and two media comperes at the mercy of an inquisitive evening audience), "Science in the Bush" (rather gentler presentations during the day, with coffee instead of beer), and "Starry Starry Night" (astronomers exploring the cultural side of their science under the stars, with an Aboriginal Dreamtime

interpreter, a famous musician and a few telescopes). Spice it with school visits, slide shows and the odd civic reception, and you have a potent mixture.

Of course, this was strictly an extra-mural activity, but the AAO featured prominently in many of the events. Indeed, it had played a significant part in the project's gestation, for it was in my office at the AAT that Robyn Stutchbury (inspired originator and manager of the project), Michael Burton (of UNSW), Wilson da Silva (of "Newton" magazine) and yours truly drew the threads of the trip together last November. So, when Robyn's fund-raising, cajoling, organising, promotion and general encouragement had finally run its course, off we went. Friday 5th May dawned to record-breaking overnight rain in central NSW, but after a spectacular landing through a 300-ft cloud-base in Dubbo to pick up the guitar (and me), the team headed west through clearing skies towards Broken Hill, our first venue. Then came Birdsville, Longreach, Charleville and, finally, Bourke. A week ago they were just names on a map; now they are smiling faces, cheerful venues, cramped accommodation, blue skies, and a landscape more reminiscent of Ireland than central Australia because of all the rain.



Most extraordinary was Birdsville, a tiny community at the edge of the Simpson Desert, where the pub is literally at the end of the runway. (A statistic to reckon with: the Diamantina Shire in which Birdsville is situated covers an area the size of Denmark — and has a total population of 200.) The swollen, kilometre-wide Diamantina River made ground-travel difficult, but we braved flooded roads to present "Science in the Bush" at Roseberth, an

historic and scenically stunning cattle station. Our hosts, the Morton family, told us that Roseberth covered a modest 2,500 square miles...



Birdsville won my heart, but it was the children of the outback who stole it completely. There is nothing quite like sitting in a studio of the School of the Air being greeted by dozens of young, almost babyish voices from isolated homesteads chorusing "Good mor-ning Mis-ter Wat-son". Their appetite for astronomy was insatiable, and when I finished off with a very silly song about aliens their applause over the loudspeaker was as enthusiastic as any on the trip. Heart-warming stuff, I can tell you.

And the tour was a great opportunity to spend time with two good friends: David, of course (seen on the left in improvised headgear — an oven mitt — near Birdsville), and Ross Edwards, one of Australia's best-known contemporary composers. Our afternoon "Art meets Science" sessions featured David's stunning AAO images juxtaposed with a video clip of Ross's sublime "Dawn Mantras", which was performed on the sails of the Sydney Opera House before a TV audience of 2 billion people to greet the new millennium. I don't believe anyone left these sessions unmoved by what they had seen and heard.



Though the TV crews who were supposed to be accompanying us didn't materialise, the tour had a high media profile. Most complete is the copiously-illustrated diary of ABC personality Bernie Hobbs, which can be found on <http://www.abc.net.au/science/outback/>.



Of course, we made mistakes on the trip, and learned what could be done better next time, but overall it seems to have been an outstanding success. Reflecting on the whole thing after I arrived home, several thoughts came to mind. First was that considering how lively and outspoken most of the participants were, the general level of harmony between us was nothing short of astonishing. Secondly, I was very conscious of the debt owed to Helen Edwards, Phillippa Malin and Trish Watson, the unsung stay-at-homes who enabled Ross, David and me to do what we did in promoting the AAO. And last was that my long-held suspicion that Coonabarabran has far more in common with suburban Sydney than outback Australia has been totally confirmed. We really are just a slightly remote corner of the metropolitan area. Good thing we don't have their lights, though.

Acknowledgements

The Department of Industry, Science and Resources (through its Science and Technology Awareness Program) and the University of NSW Faculty of Science and Technology were major sponsors of "Science in the Pub", "Science in the Bush", school visits and distance education broadcasts, whilst the U Committee of the University of NSW sponsored "Starry Starry Night". Other sponsors include the Australian Mathematics Society, the Garvan Institute, the Australia Telescope National Facility, Sydney Observatory (Powerhouse Museum), New Scientist, Macquarie University, and a number of the outback centres. National Science Week is an initiative of the Australian Science Festival, the Australian Science Teachers' Association and the Australian Broadcasting Commission.

PUZZLE SOLUTIONS

The winner of the Caption Competition (November 99 Issue) was Keith Shortridge by a country mile, who will (finally!) receive the Year 2000 AAO Calendar. Well, half a year is better than none! Here they are:

- (7) That @#! Roger Bell. He put the sticky on the wrong side.
- (6) "And this one shows the random number generator used to calculate the project completion date"
- (5) "If you look through here, you can see right up the Mayor's nose!"
- (4) The 2dF "which of these photographs is upside down?" competition generated a great deal of interest.
- (3) If the Director was going to wear a kilt, it may have been wiser had he kept off the raised walkway around the photo gallery.
- (2) "My goodness, you're right! I can hear it play the 1812 overture"
- (1) In this still from the pilot episode of the X-Files, Mulder and Scully infiltrate a scientific conference in search of aliens who can only be recognised by the give-away presence of green nasal hair.

Congratulations to Denis Coates of Monash University, Melbourne, who receives a print of the Horsehead Nebula for his solution of the February AAO Crossword. Many thanks for those who entered, and particularly to Elaine Sadler and Keith Shortridge for their creative efforts. The correct answers are shown here and on the web at <http://www.aao.gov.au/local/www/ks/crossword/>.

	L	I	B	R	A		W	E	L	L	F	E	D		
O	N	E		S	R									C	
U	R	S	A	M	I	N	O	R		V	I	R	G	O	
T		I		E		I				I		U		N	
E	P	S	O	M		C	E	N	T	A	U	R	U	S	
R		T		B		K		G						T	
M	A	S	T	E	R	E	D			O	B	L	A	T	E
O					R		R		F		U				L
N	I	C	E	S	T		P	A	S	T	O	R	A	L	
G		H				C		R			T		A	A	
O	R	A	N	G	E	A	D	E			E	D	I	C	T
L		N			A		R			A					I
I	N	D	U	S			I	P	S	O	F	A	C	T	O
A		R		E			N			T		L		A	N
	C	A	P	S	T	A	N			H	Y	D	R	A	



David Lee.

Schematic of 10 d-IFU fibre probes situated on 10' Gemini field of view

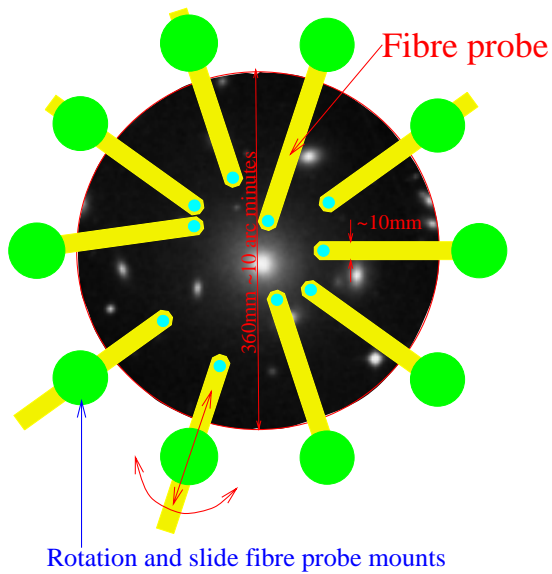

Image shown is COMA cluster.

External Projects at the AAO

GIRMOS Development Study

AAO has recently expanded into designing and building instrumentation for telescopes other than our own AAT and UKST. An article on page 10 describes the current external projects.

As an example, these figures (created by David Lee) show a design for d-IFUs for GIRMOS, a multi-object spectrograph for GEMINI designed to operate in the 1 – 2.5 micron region. Each d-IFU is somewhat like SPIRAL, only there will be 10 – 20 of the units, able to be driven over the 10 arcmin field of view on Gemini. Roger Haynes, as project scientist, is carrying out a feasibility study for d-IFUs constructed of optical fibres and a micro-lens array. The upper figure shows a schematic of 10 d-IFU units or fibre probes positioned over the Coma cluster, and the lower figure shows the proposed design for each fibre probe



David Lee.

Schematic of a deployable-IFU using a "Fibre probe".

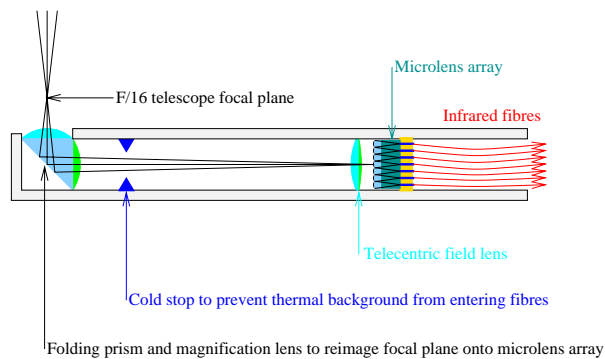

Next Issue:

If you have some recent results based on AAT or UKST data, or other items of interest, please send articles to newsletter@aaoepp.aao.gov.au by July 17, 2000. Article length can vary from 2 paragraphs to 2 pages, with preference for plain or latex text and gif or postscript images.

editor RAY STATHAKIS editorial assistant SANDRA RICKETTS

ISSN 0728-5833
Published by ANGLO-AUSTRALIAN OBSERVATORY
PO Box 296 Epping, NSW 1710 Australia

Epping Lab
Telephone +61 2 9372 4800 Fax +61 2 9372 4880 email < user@aaoepp.aao.gov.au >

AAT/Schmidt
Telephone +61 2 6842 6291 Fax +61 2 6884 2298 email < user@aocbn.aao.gov.au >

URL < <http://www.aao.gov.au> >

